

## M12 B code male moldable connector, unshielded/M12, B型公头成型式连接器, 不带屏蔽

Illustration/尺寸

Product photo/产品图

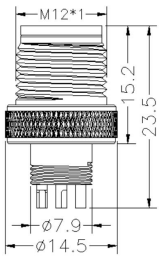

Part number/产品料号

Pins/针数	Code/型	Part number/产品料号
5pins/5针	B code/B型	12C087

Pin assignment front view/针位分布前视图

B code 5pins  
B型5针

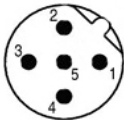

General data/常规数据

Pins Numbers/针数	5pins/5针
Rated voltage/额定电压	60V
Rated current(40°C)/额定电流	4A
Standards/标准	IEC 61076-2-101
Termination/焊接方式	solder/焊接
Degree of protection/防护等级	IP67, IP68, IP69K
Wire gauge(mm²)/线规(平方数)	0.14mm²-0.75mm²
Wire gauge(AWG)/线号(平方数)	26AWG-18AWG
Mechanical operation/插拔次数	>100 mating cycles/大于100次
Ambient temperature (operation)/操作温度	-25°C~+85°C
Contact resistance/接触电阻	≤5mΩ
Insulation resistance/绝缘电阻	≥100MΩ
Connector body/胶芯	TPU
Pins/端子	Brass with gold plated/黄铜镀金
Screw/螺丝	Brass with nickel plated/黄铜镀镍
Environmental compliance/环境符合标准	RoHs, Reach

## M12 B code female moldable connector, unshielded/M12, B型母头成型式连接器, 不带屏蔽

Illustration/尺寸

Product photo/产品图

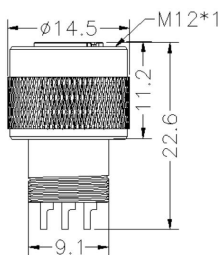

Part number/产品料号

Pins/孔数	Code/型	Part number/产品料号
5pins/5孔	B code/B型	12C088

Pin assignment front view/孔位分布前视图

B code 5pins  
B型5孔

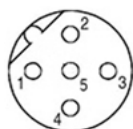

General data/常规数据

Pins Numbers/孔数	5pins/5孔
Rated voltage/额定电压	60V
Rated current(40°C)/额定电流	4A
Standards/标准	IEC 61076-2-101
Termination/焊接方式	solder/焊接
Degree of protection/防护等级	IP67, IP68, IP69K
Wire gauge(mm²)/线规(平方数)	0.14mm²-0.75mm²
Wire gauge(AWG)/线号(平方数)	26AWG-18AWG
Mechanical operation/插拔次数	>100 mating cycles/大于100次
Ambient temperature (operation)/操作温度	-25°C~+85°C
Contact resistance/接触电阻	≤5mΩ
Insulation resistance/绝缘电阻	≥100MΩ
Connector body/胶芯	TPU
Pins/端子	Phosphorus copper with gold plated/磷铜镀金
Screw/螺丝	Brass with nickel plated/黄铜镀镍
Gasket material/胶圈	Fluorine ring/氟胶圈
Environmental compliance/环境符合标准	RoHs, Reach

## M12 B code male moldable connector with shielded/M12, B型公头成型式连接器, 带屏蔽

Illustration/尺寸

Product photo/产品图

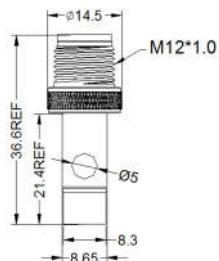

### Part number/产品料号

Pins/针数	Code/型	Part number/产品料号
5pins/5针	B code/B型	12C125

### Pin assignment front view/针位分布前视图

B code 5pins  
B型5针

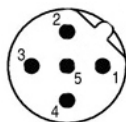

### General data/常规数据

Pins Numbers/针数	5pins/5针
Rated voltage/额定电压	60V
Rated current(40°C)/额定电流	4A
Standards/标准	IEC 61076-2-101
Termination/焊接方式	solder/焊接
Degree of protection/防护等级	IP67, IP68, IP69K
Wire gauge(mm²)/线规(平方数)	0.14mm²-0.75mm²
Wire gauge(AWG)/线号(平方数)	26AWG-18AWG
Mechanical operation/插拔次数	>100 mating cycles/大于100次
Ambient temperature (operation)/操作温度	-25°C~+85°C
Contact resistance/接触电阻	≤5mΩ
Insulation resistance/绝缘电阻	≥100MΩ
Connector body/胶芯	TPU
Pins/端子	Brass with gold plated/黄铜镀金
Screw/螺丝	Brass with nickel plated/黄铜镀镍
Environmental compliance/环境符合标准	RoHs, Reach

## M12 B code female moldable connector with shielded/M12, B型母头成型式连接器, 带屏蔽

Illustration/尺寸

Product photo/产品图

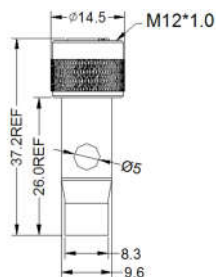

Part number/产品料号

Pins/孔数	Code/型	Part number/产品料号
5pins/5孔	B code/B型	12C126

Pin assignment front view/孔位分布前视图

B code 5pins  
B型5孔

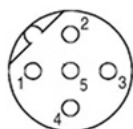

General data/常规数据

Pins Numbers/孔数	5pins/5孔
Rated voltage/额定电压	60V
Rated current(40°C)/额定电流	4A
Standards/标准	IEC 61076-2-101
Termination/焊接方式	solder/焊接
Degree of protection/防护等级	IP67, IP68, IP69K
Wire gauge(mm²)/线规(平方数)	0.14mm²-0.75mm²
Wire gauge(AWG)/线号(平方数)	26AWG-18AWG
Mechanical operation/插拔次数	>100 mating cycles/大于100次
Ambient temperature (operation)/操作温度	-25°C~+85°C
Contact resistance/接触电阻	≤5mΩ
Insulation resistance/绝缘电阻	≥100MΩ
Connector body/胶芯	TPU
Pins/端子	Phosphorus copper with gold plated/磷铜镀金
Screw/螺丝	Brass with nickel plated/黄铜镀镍
Gasket/胶圈	Fluorine ring/氟胶圈
Environmental compliance/环境符合标准	RoHs, Reach

## M12 B code male straight front panel mount connector, unshielded, insert/M12, B型公头直头前锁面板板端, 不带屏蔽

### Illustration/尺寸

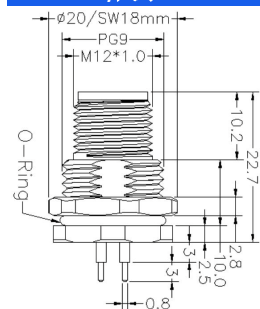

### Product photo/产品图



### Part number/产品料号

Pins/针数	Code/型	Part number/产品料号	
		PG9 thread 15.3±0.1/PG9螺纹15.3±0.1	M16 thread 16±0.1/M16螺纹16±0.1
5pins/5针	B code/B型	12B041	12B045

### Pin assignment front view/针位分布前视图

B code 5pins  
B型5针

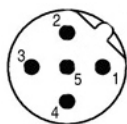

### General data/常规数据

Pins Numbers/针数	5pins/5针
Rated voltage/额定电压	60V
Rated current(40°C)/额定电流	4A
Standards/标准	IEC 61076-2-101
Termination/焊接方式	solder PCB/PCB焊接
Connector locking system/锁紧方式	Screw/螺锁
Degree of protection/防护等级	IP67, IP68, IP69K
Mechanical operation/插拔次数	>100 mating cycles/大于100次
Ambient temperature (operation)/操作温度	-25°C~+85°C
Contact resistance/接触电阻	≤5mΩ
Insulation resistance/绝缘电阻	≥100MΩ
Connector body/胶芯	TPU
Pins/端子	Brass with gold plated/黄铜镀金
Screw/螺丝	Brass with nickel plated/黄铜镀镍
Gasket/胶圈	Fluorine ring/氟胶圈
Environmental compliance/环境符合标准	RoHs, Reach

## M12 B code female straight front panel mount connector, unshielded, insert/M12, B型母头直头前锁面板板端, 不带屏蔽

Illustration/尺寸

Product photo/产品图

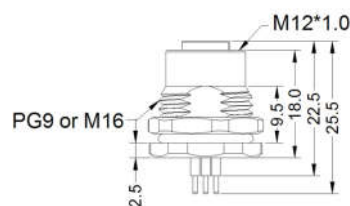

### Part number/产品料号

Pins/孔数	Code/型	Part number/产品料号	
		PG9 thread 15.3±0.1/PG9螺纹15.3±0.1	M16 thread 16±0.1/M16螺纹16±0.1
5pins/5孔	B code/B型	12B043	12B047

### Pin assignment front view/孔位分布前视图

B code 5pins  
B型5孔

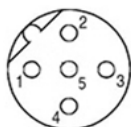

### General data/常规数据

Pins Numbers/孔数	5pins/5孔
Rated voltage/额定电压	60V
Rated current(40°C)/额定电流	4A
Standards/regulations/标准	IEC 61076-2-101
Termination/焊接方式	solder PCB/PCB焊接
Connector locking system/锁紧方式	Screw/螺锁
Degree of protection/防护等级	IP67, IP68, IP69K
Mechanical operation/插拔次数	>100 mating cycles/大于100次
Ambient temperature (operation)/操作温度	-25°C~+85°C
Contact resistance/接触电阻	≤5mΩ
Insulation resistance/绝缘电阻	≥100MΩ
Connector body/胶芯	TPU
Pins/端子	Phosphorus copper with gold plated/磷铜镀金
Screw/螺丝	Brass with nickel plated/黄铜镀镍
Gasket/胶圈	Fluorine ring/氟胶圈
Environmental compliance/环境符合标准	RoHs, Reach

## M12 B code male straight rear panel mount connector, unshielded, insert/M12, B型公头直头后锁面板端, 不带屏蔽

Illustration/尺寸

Product photo/产品图

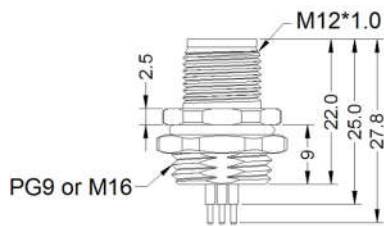

Part number/产品料号

Pins/针数	Code/型	Part number/产品料号	
		PG9 thread 15.3±0.1/PG9螺纹15.3±0.1	M16 thread 16±0.1/M16螺纹16±0.1
5pins/5针	B code/B型	12B042	12B046

Pin assignment front view/针位分布前视图

B code 5pins  
B型5针



General data/常规数据

Pins Numbers/针数	5pins/5针
Rated voltage/额定电压	60V
Rated current(40°C)/额定电流	4A
Standards/标准	IEC 61076-2-101
Termination/焊接方式	solder PCB/PCB焊接
Connector locking system/锁紧方式	Screw/螺锁
Degree of protection/防护等级	IP67, IP68, IP69K
Mechanical operation/插拔次数	>100 mating cycles/大于100次
Ambient temperature (operation)/操作温度	-25°C~+85°C
Contact resistance/接触电阻	≤5mΩ
Insulation resistance/绝缘电阻	≥100MΩ
Connector body/胶芯	TPU
Pins/端子	Brass with gold plated/黄铜镀金
Screw/螺丝	Brass with nickel plated/黄铜镀镍
Gasket/胶圈	Fluorine ring/氟胶圈
Environmental compliance/环境符合标准	RoHS, Reach

**M12 B code female straight rear panel mount connector, unshielded, insert/M12, B型母头直头后锁面板板端, 不带屏蔽**

Illustration/尺寸

Product photo/产品图

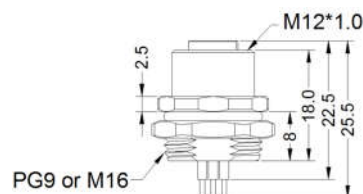

Part number/产品料号

Pins/孔数	Code/型	Part number/产品料号	
		PG9 thread 15.3±0.1/PG9螺纹15.3±0.1	M16 thread 16±0.1/M16螺纹16±0.1
5pins/5孔	B code/B型	12B044	12B048

Pin assignment front view/孔位分布前视图

B code 5pins  
 B型5孔

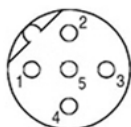

General data/常规数据

Pins Numbers/孔数	5pins/5孔
Rated voltage/额定电压	60V
Rated current(40°C)/额定电流	4A
Standards/标准	IEC 61076-2-101
Termination/焊接方式	solder PCB/PCB焊接
Connector locking system/锁紧方式	Screw/螺锁
Degree of protection/防护等级	IP67, IP68, IP69K
Mechanical operation/插拔次数	>100 mating cycles/大于100次
Ambient temperature (operation)/操作温度	-25°C~+85°C
Contact resistance/接触电阻	≤5mΩ
Insulation resistance/绝缘电阻	≥100MΩ
Connector body/胶芯	TPU
Pins/端子	Phosphorus copper with gold plated/磷铜镀金
Screw/螺丝	Brass with nickel plated/黄铜镀镍
Gasket/胶圈	Fluorine ring/氟胶圈
Environmental compliance/环境符合标准	RoHs, Reach



**M12 5pins B code male straight front panel mount connector, unshielded, solder/M12,5针,B型公头直头前锁面板焊线式,不带屏蔽**

Illustration/尺寸

Product photo/产品图

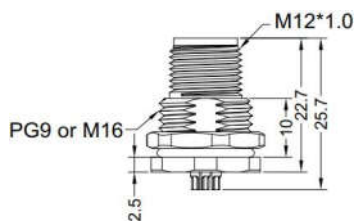

Part number/产品料号

Pins/针数	Code/型	Part number("X" is length millimetre mm)/产品料号("X"表示长度, 单位毫米mm)	
5pins/5针	B code/B型	PG9 thread 15.3±0.1/PG9螺纹15.3±0.1	M16 thread 16±0.1/M16螺纹16±0.1
		12H041-X	12H045-X

Pin assignment front view/针位分布前视图

B code 5pins  
B型5针

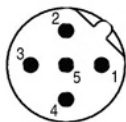

General data/常规数据

Pins Numbers/针数	5pins/5针
Rated voltage/额定电压	60V
Rated current(40°C)/额定电流	4A
Standards/标准	IEC 61076-2-101
Termination/焊接方式	solder/焊接
Connector locking system/锁紧方式	Screw/螺锁
Degree of protection/防护等级	IP67, IP68, IP69K
Wire gauge(mm²)/线规(平方数)	0.14mm²-0.75mm²
Wire gauge(AWG)/线号(平方数)	26AWG-18AWG
Mechanical operation/插拔次数	>100 mating cycles/大于100次
Ambient temperature (operation)/操作温度	-40°C~+85°C
Contact resistance/接触电阻	≤5mΩ
Insulation resistance/绝缘电阻	≥100MΩ
Connector body/胶芯	TPU
Pins/端子	Brass with gold plated/黄铜镀金
Screw/螺丝	Brass with nickel plated/黄铜镀镍
Gasket/胶圈	Fluorine ring/氟胶圈
Environmental compliance/环境符合标准	RoHs, Reach

**M12 5pins B code female straight front panel mount connector, unshielded, solder/M12,5针,B型母头直头前锁面板焊线式,不带屏蔽**

Illustration/尺寸

Product photo/产品图

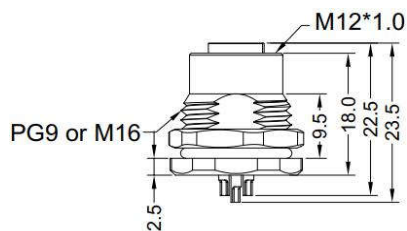

Part number/产品料号

Pins/针数	Code/型	Part number("X" is length millimetre mm)/产品料号("X"表示长度, 单位毫米mm)	
5pins/5针	B code/B型	PG9 thread 15.3±0.1/PG9螺纹15.3±0.1	M16 thread 16±0.1/M16螺纹16±0.1
		12H043-X	12H047-X

Pin assignment front view/针位分布前视图

B code 5pins  
B型5针

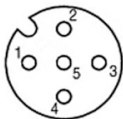

General data/常规数据

Pins Numbers/针数	5pins/5针
Rated voltage/额定电压	60V
Rated current(40°C)/额定电流	4A
Standards/标准	IEC 61076-2-101
Termination/焊接方式	solder/焊接
Connector locking system/锁紧方式	Screw/螺锁
Degree of protection/防护等级	IP67, IP68, IP69K
Wire gauge(mm²)/线规(平方数)	0.14mm²-0.75mm²
Wire gauge(AWG)/线号(平方数)	26AWG-18AWG
Mechanical operation/插拔次数	>100 mating cycles/大于100次
Ambient temperature (operation)/操作温度	-40°C~+85°C
Contact resistance/接触电阻	≤5mΩ
Insulation resistance/绝缘电阻	≥100MΩ
Connector body/胶芯	TPU
Pins/端子	Brass with gold plated/黄铜镀金
Screw/螺丝	Brass with nickel plated/黄铜镀镍
Gasket/胶圈	Fluorine ring/氟胶圈
Environmental compliance/环境符合标准	RoHs, Reach

**M12 5pins B code male straight rear panel mount connector , unshielded, solder/M12,5针,B型公头直头后锁面板焊线式,不带屏蔽**

Illustration/尺寸

Product photo/产品图

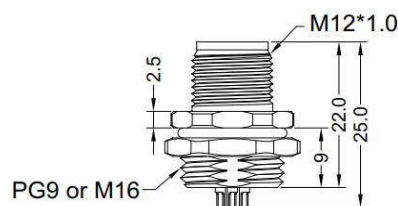

Part number/产品料号

Pins/针数	Code/型	Part number("X" is length millimetre mm)/产品料号("X"表示长度, 单位毫米mm)	
5pins/5针	B code/B型	PG9 thread 15.3±0.1/PG9螺纹15.3±0.1	M16 thread 16±0.1/M16螺纹16±0.1
		12H042-X	12H046-X

Pin assignment front view/针位分布前视图

B code 5pins  
B型5针

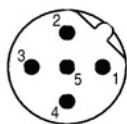

General data/常规数据

Pins Numbers/针数	5pins/5针
Rated voltage/额定电压	60V
Rated current(40°C)/额定电流	4A
Standards/标准	IEC 61076-2-101
Termination/焊接方式	solder/焊接
Connector locking system/锁紧方式	Screw/螺锁
Degree of protection/防护等级	IP67, IP68, IP69K
Wire gauge(mm²)/线规(平方数)	0.14mm²-0.75mm²
Wire gauge(AWG)/线号(平方数)	26AWG-18AWG
Mechanical operation/插拔次数	>100 mating cycles/大于100次
Ambient temperature (operation)/操作温度	-40°C~+85°C
Contact resistance/接触电阻	≤5mΩ
Insulation resistance/绝缘电阻	≥100MΩ
Connector body/胶芯	TPU
Pins/端子	Brass with gold plated/黄铜镀金
Screw/螺丝	Brass with nickel plated/黄铜镀镍
Gasket/胶圈	Fluorine ring/氟胶圈
Environmental compliance/环境符合标准	RoHs, Reach

**M12 5pins B code female straight rear panel mount connector, unshielded, solder/M12,5针,B型母头直头后锁面板焊线式,不带屏蔽**

Illustration/尺寸

Product photo/产品图

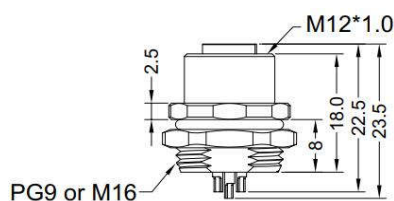

Part number/产品料号

Pins/针数	Code/型	Part number("X" is length millimetre mm)/产品料号("X"表示长度, 单位毫米mm)	
5pins/5针	B code/B型	PG9 thread 15.3±0.1/PG9螺纹15.3±0.1	M16 thread 16±0.1/M16螺纹16±0.1
		12H044-X	12H048-X

Pin assignment front view/针位分布前视图

B code 5pins  
B型5针

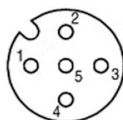

General data/常规数据

Pins Numbers/针数	5pins/5针
Rated voltage/额定电压	60V
Rated current(40°C)/额定电流	4A
Standards/标准	IEC 61076-2-101
Termination/焊接方式	solder/焊接
Connector locking system/锁紧方式	Screw/螺锁
Degree of protection/防护等级	IP67, IP68, IP69K
Wire gauge(mm²)/线规(平方数)	0.14mm²-0.75mm²
Wire gauge(AWG)/线号(平方数)	26AWG-18AWG
Mechanical operation/插拔次数	>100 mating cycles/大于100次
Ambient temperature (operation)/操作温度	-40°C~+85°C
Contact resistance/接触电阻	≤5mΩ
Insulation resistance/绝缘电阻	≥100MΩ
Connector body/胶芯	TPU
Pins/端子	Brass with gold plated/黄铜镀金
Screw/螺丝	Brass with nickel plated/黄铜镀镍
Gasket/胶圈	Fluorine ring/氟胶圈
Environmental compliance/环境符合标准	RoHs, Reach

**M12 B code male straight front panel mount connector, unshielded, single wires/M12, B型公头直头前锁面板带线, 不带屏蔽**

Illustration/尺寸

Product photo/产品图

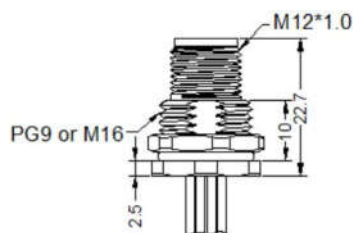

**Part number/产品料号**

Pins/针数	Code/型	Part number("X" is length millimetre mm)/产品料号("X"表示长度, 单位毫米mm)	
5pins/5针	B code/B型	PG9 thread 15.3±0.1/PG9螺纹15.3±0.1	M16 thread 16±0.1/M16螺纹16±0.1
		12D041-X	12D045-X

**Pin assignment front view/针位分布前视图**

B code 5pins  
B型5针

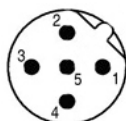

**General data/常规数据**

Pins Numbers/针数	5pins/5针
Rated voltage/额定电压	60V
Rated current(40°C)/额定电流	4A
Standards/标准	IEC 61076-2-101
Termination/焊接方式	solder/焊接
Connector locking system/锁紧方式	Screw/螺锁
Degree of protection/防护等级	IP67, IP68, IP69K
Wire gauge(mm²)/线规(平方数)	0.14mm²-0.75mm²
Wire gauge(AWG)/线号(平方数)	26AWG-18AWG
Mechanical operation/插拔次数	>100 mating cycles/大于100次
Ambient temperature (operation)/操作温度	-40°C~+85°C
Contact resistance/接触电阻	≤5mΩ
Insulation resistance/绝缘电阻	≥100MΩ
Connector body/胶芯	TPU
Pins/端子	Brass with gold plated/黄铜镀金
Screw/螺丝	Brass with nickel plated/黄铜镀镍
Gasket/胶圈	Fluorine ring/氟胶圈
Environmental compliance/环境符合标准	RoHs, Reach

## M12 B code female straight front panel mount connector, unshielded, single wires/M12, B型母头直头前锁面板带线, 不带屏蔽

Illustration/尺寸

Product photo/产品图

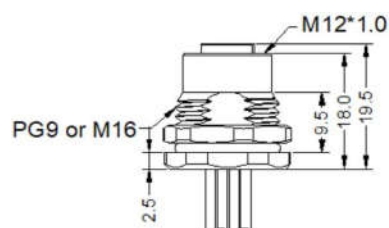

Part number/产品料号

Pins/孔数	Code/型	Part number("X" is length millimetre mm)/产品料号("X"表示长度, 单位毫米mm)	
5pins/5孔	B code/B型	PG9 thread 15.3±0.1/PG9螺纹15.3±0.1	M16 thread 16±0.1/M16螺纹16±0.1
		12D043-X	12D047-X

Pin assignment front view/孔位分布前视图

B code 5pins  
B型5孔

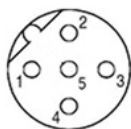

General data/常规数据

Pins Numbers/孔数	5pins/5孔
Rated voltage/额定电压	60V
Rated current(40°C)/额定电流	4A
Standards/标准	IEC 61076-2-101
Termination/焊接方式	solder/焊接
Connector locking system/锁紧方式	Screw/螺锁
Degree of protection/防护等级	IP67, IP68, IP69K
Wire gauge(mm²)/线规(平方数)	0.14mm²-0.75mm²
Wire gauge(AWG)/线号(平方数)	26AWG-18AWG
Mechanical operation/插拔次数	>100 mating cycles/大于100次
Ambient temperature (operation)/操作温度	-40°C~+85°C
Contact resistance/接触电阻	≤5mΩ
Insulation resistance/绝缘电阻	≥100MΩ
Connector body/胶芯	TPU
Pins/端子	Phosphorus copper with gold plated/磷铜镀金
Screw/螺丝	Brass with nickel plated/黄铜镀镍
Gasket/胶圈	Fluorine ring/氟胶圈
Environmental compliance/环境符合标准	RoHs, Reach

## M12 B code male straight rear panel mount connector, unshielded, single wires/M12, B型公头直头后锁面板带线, 不带屏蔽

Illustration/尺寸

Product photo/产品图

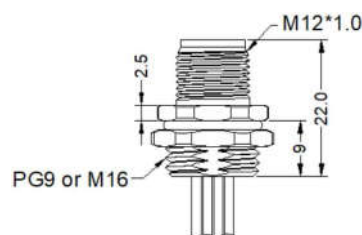

Part number/产品料号

Pins/针数	Code/型	Part number("X" is length millimetre mm)/产品料号("X"表示长度, 单位毫米mm)	
5pins/5针	B code/B型	PG9 thread 15.3±0.1/PG9螺纹15.3±0.1	M16 thread 16±0.1/M16螺纹16±0.1
		12D042-X	12D046-X

Pin assignment front view/针位分布前视图

B code 5pins  
B型5针

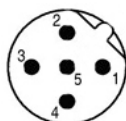

General data/常规数据

Pins Numbers/针数	5pins/5针
Rated voltage/额定电压	60V
Rated current(40°C)/额定电流	4A
Standards/标准	IEC 61076-2-101
Termination/焊接方式	solder/焊接
Connector locking system/锁紧方式	Screw/螺锁
Degree of protection/防护等级	IP67, IP68, IP69K
Wire gauge(mm²)/线规(平方数)	0.14mm²-0.75mm²
Wire gauge(AWG)/线号(平方数)	26AWG-18AWG
Mechanical operation/插拔次数	>100 mating cycles/大于100次
Ambient temperature (operation)/操作温度	-40°C~+85°C
Contact resistance/接触电阻	≤5mΩ
Insulation resistance/绝缘电阻	≥100MΩ
Connector body/胶芯	TPU
Pins/端子	Brass with gold plated/黄铜镀金
Screw/螺丝	Brass with nickel plated/黄铜镀镍
Gasket/胶圈	Fluorine ring/氟胶圈
Environmental compliance/环境符合标准	RoHs, Reach

**M12 B code female straight rear panel mount connector, unshielded, single wires/M12, B型母头直头后锁面板带线, 不带屏蔽**

Illustration/尺寸

Product photo/产品图

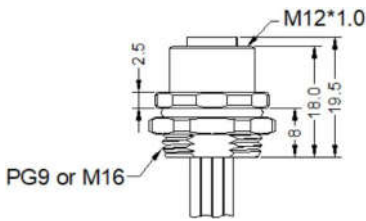

Part number/产品料号

Pins/孔数	Code/型	Part number("X" is length millimetre mm)/产品料号("X"表示长度, 单位毫米mm)	
5pins/5孔	B code/B型	PG9 thread 15.3±0.1/PG9螺纹15.3±0.1	M16 thread 16±0.1/M16螺纹16±0.1
		12D044-X	12D048-X

Pin assignment front view/孔位分布前视图

B code 5pins  
B型5孔



General data/常规数据

Pins Numbers/孔数	5pins/5孔
Rated voltage/额定电压	60V
Rated current(40°C)/额定电流	4A
Standards/标准	IEC 61076-2-101
Termination/焊接方式	solder/焊接
Connector locking system/锁紧方式	Screw/螺锁
Degree of protection/防护等级	IP67, IP68, IP69K
Wire gauge(mm²)/线规(平方数)	0.14mm²-0.75mm²
Wire gauge(AWG)/线号(平方数)	26AWG-18AWG
Mechanical operation/插拔次数	>100 mating cycles/大于100次
Ambient temperature (operation)/操作温度	-40°C~+85°C
Contact resistance/接触电阻	≤5mΩ
Insulation resistance/绝缘电阻	≥100MΩ
Connector body/胶芯	TPU
Pins/端子	Phosphorus copper with gold plated/磷铜镀金
Screw/螺丝	Brass with nickel plated/黄铜镀镍
Gasket material/胶圈材料	Fluorine ring/氟胶圈
Environmental compliance/环境符合标准	RoHs, Reach



## M12 B code male straight plastic assembly connector, unshielded/M12, B型公头直头塑胶装配式连接器, 不带屏蔽

Illustration/尺寸

Product photo/产品图

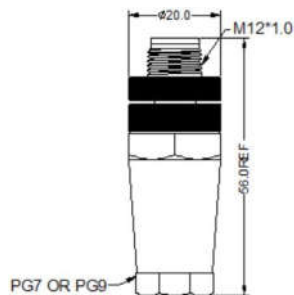

Part number/产品料号

Pins/针数	Code/型	Part number/产品料号	
5pins/5针	B code/B型	PG7 thread/PG7螺纹	PG9 thread/PG9螺纹
		12ZU51-PG7	12ZU51-PG9

Pin assignment front view/针位分布前视图

B code 5pins  
B型5针

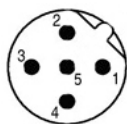

General data/常规数据

Pins Numbers/针数	5pins/5针
Rated voltage/额定电压	60V
Rated current(40°C)/额定电流	4A
Standards/标准	IEC 61076-2-101
Termination/焊接方式	screw clamp/螺锁
Degree of protection/防护等级	IP67
Wire gauge(mm²)/线规(平方数)	0.14mm²-0.75mm²
Wire gauge(AWG)/线号(平方数)	26AWG-18AWG
Suitable cable outer diameter/适合线材外径	4.0mm-8.0mm
Mechanical operation/插拔次数	>100 mating cycles/大于100次
Ambient temperature (operation)/操作温度	-25°C~+85°C
Contact resistance/接触电阻	≤5mΩ
Insulation resistance/绝缘电阻	≥100MΩ
Connector body/胶芯	TPU
Pins/端子	Brass with gold plated/黄铜镀金
Screw/螺丝	Brass with nickel plated/黄铜镀镍
Gasket/胶圈	Fluorine ring/氟胶圈
PG7: Cable diameter 4mm~6mm	PG9: Cable diameter 6mm~8mm
Environmental compliance/环境符合标准	RoHS, Reach

## M12 B code female straight plastic assembly connector, unshielded/M12, B型母头直头塑胶装配式连接器, 不带屏蔽

Illustration/尺寸

Product photo/产品图

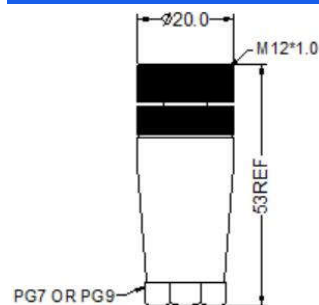

Part number/产品料号

Pins/孔数	Code/型	Part number/产品料号	
5pins/5孔	B code/B型	PG7 thread/PG7螺纹	PG9 thread/PG9螺纹
		12ZU52-PG7	12ZU52-PG9

Pin assignment front view/孔位分布前视图

B code 5pins

B型5孔

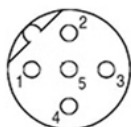

General data/常规数据

Pins Numbers/孔数	5pins/5孔
Rated voltage/额定电压	60V
Rated current(40°C)/额定电流	4A
Standards/标准	IEC 61076-2-101
Termination/焊接方式	screw clamp/螺锁
Degree of protection/防护等级	IP67
Wire gauge(mm²)/线规(平方数)	0.14mm²-0.75mm²
Wire gauge(AWG)/线号(平方数)	26AWG-18AWG
Suitable cable outer diameter/适合线材外径	4.0mm-8.0mm
Mechanical operation/插拔次数	>100 mating cycles/大于100次
Ambient temperature (operation)/操作温度	-25°C~+85°C
Contact resistance/接触电阻	≤5mΩ
Insulation resistance/绝缘电阻	≥100MΩ
Connector body/胶芯	TPU
Pins/端子	Phosphorus copper with gold plated/磷铜镀金
Screw/螺丝	Brass with nickel plated/黄铜镀镍
Gasket/胶圈	Fluorine ring/氟胶圈
PG7: Cable diameter 4mm~6mm	PG9: Cable diameter 6mm~8mm
Environmental compliance/环境符合标准	RoHS, Reach

## M12 B code male right angle plastic assembly connector, unshielded/M12, B型公头弯头塑胶装配式连接器, 不带屏蔽

Illustration/尺寸

Product photo/产品图

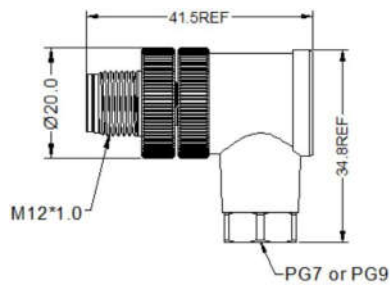

Part number/产品料号

Pins/针数	Code/型	Part number/产品料号	
		PG7 thread/PG7螺纹	PG9 thread/PG9螺纹
5pins/5针	B code/B型	12ZU53-PG7	12ZU53-PG9

Pin assignment front view/针位分布前视图

B code 5pins  
B型5针



General data/常规数据

Pins Numbers/针数	5pins/5针
Rated voltage/额定电压	60V
Rated current(40°C)/额定电流	4A
Standards/标准	IEC 61076-2-101
Termination/焊接方式	screw clamp/螺锁
Degree of protection/防护等级	IP67
Wire gauge(mm²)/线规(平方数)	0.14mm²-0.75mm²
Wire gauge(AWG)/线号(平方数)	26AWG-18AWG
Suitable cable outer diameter/适合线材外径	4.0mm-8.0mm
Mechanical operation/插拔次数	>100 mating cycles/大于100次
Ambient temperature (operation)/操作温度	-25°C~+85°C
Contact resistance/接触电阻	≤5mΩ
Insulation resistance/绝缘电阻	≥100MΩ
Connector body/胶芯	TPU
Pins/端子	Brass with gold plated/黄铜镀金
Screw/螺丝	Brass with nickel plated/黄铜镀镍
Gasket/胶圈	Fluorine ring/氟胶圈
PG7: Cable diameter 4mm~6mm	PG9: Cable diameter 6mm~8mm
Environmental compliance/环境符合标准	RoHS, Reach

## M12 B code female right angle plastic assembly connector, unshielded/M12, B型母头弯头塑胶装配式连接器, 不带屏蔽

Illustration/尺寸

Product photo/产品图

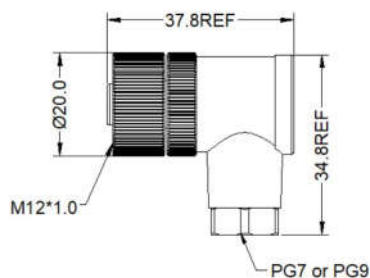

Part number/产品料号

Pins/孔数	Code/型	Part number/产品料号	
		PG7 thread/PG7螺纹	PG9 thread/PG9螺纹
5pins/5孔	B code/B型	12ZU54-PG7	12ZU54-PG9

Pin assignment front view/孔位分布前视图

B code 5pins

B型5孔

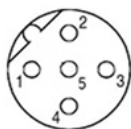

General data/常规数据

Pins Numbers/孔数	5pins/5孔
Rated voltage/额定电压	60V
Rated current(40°C)/额定电流	4A
Standards/标准	IEC 61076-2-101
Termination/焊接方式	screw clamp/螺锁
Degree of protection/防护等级	IP67
Wire gauge(mm²)/线规(平方数)	0.14mm²-0.75mm²
Wire gauge(AWG)/线号(平方数)	26AWG-18AWG
Suitable cable outer diameter/适合线材外径	4.0mm-8.0mm
Mechanical operation/插拔次数	>100 mating cycles/大于100次
Ambient temperature (operation)/操作温度	-25°C~+85°C
Contact resistance/接触电阻	≤5mΩ
Insulation resistance/绝缘电阻	≥100MΩ
Connector body/胶芯	TPU
Pins/端子	Phosphorus copper with gold plated/磷铜镀金
Screw/螺丝	Brass with nickel plated/黄铜镀镍
Gasket/胶圈	Fluorine ring/氟胶圈
PG7: Cable diameter 4mm~6mm	PG9: Cable diameter 6mm~8mm
Environmental compliance/环境符合标准	RoHs, Reach

## M12 B code male straight metal assembly connector with shielded/M12, B型公头直头金属装配式连接器, 带屏蔽

### Illustration/尺寸

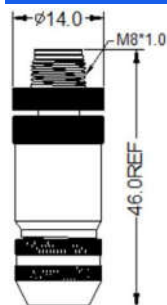

### Product photo/产品图



### Part number/产品料号

Pins/针数	Code/型	Part number/产品料号	
5pins/5针	B code/B型	PG7 thread/PG7螺纹	PG9 thread/PG9螺纹
		12ZS55-PG7	12ZS55-PG9

### Pin assignment front view/针位分布前视图

B code 5pins  
B型5针

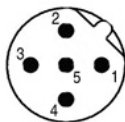

### General data/常规数据

Pins Numbers/针数	5pins/5针
Rated voltage/额定电压	60V
Rated current(40°C)/额定电流	4A
Standards/标准	IEC 61076-2-101
Termination/焊接方式	screw clamp/螺锁
Degree of protection/防护等级	IP67
Wire gauge(mm²)/线规(平方数)	0.14mm²-0.75mm²
Wire gauge(AWG)/线号(平方数)	26AWG-18AWG
Suitable cable outer diameter/适合线材外径	4.0mm-8.0mm
Mechanical operation/插拔次数	>100 mating cycles/大于100次
Ambient temperature (operation)/操作温度	-25°C~+85°C
Contact resistance/接触电阻	≤5mΩ
Insulation resistance/绝缘电阻	≥100MΩ
Connector body/胶芯	TPU
Pins/端子	Brass with gold plated/黄铜镀金
Screw/螺丝	Brass with nickel plated/黄铜镀镍
Gasket/胶圈	Fluorine ring/氟胶圈
PG7: Cable diameter 4mm~6mm	PG9: Cable diameter 6mm~8mm
Environmental compliance/环境符合标准	RoHS, Reach

## M12 B code female straight metal assembly connector with shielded/M12, B型母头直头金属装配式连接器, 带屏蔽

### Illustration/尺寸

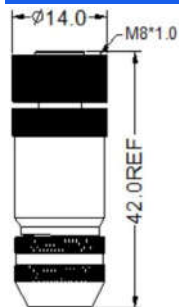

### Product photo/产品图



### Part number/产品料号

Pins/孔数	Code/型	Part number/产品料号	
		PG7 thread/PG7螺纹	PG9 thread/PG9螺纹
5pins/5孔	B code/B型	12ZS56-PG7	12ZS56-PG9

### Pin assignment front view/孔位分布前视图

B code 5pins  
B型5孔

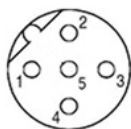

### General data/常规数据

Pins Numbers/孔数	5pins/5孔
Rated voltage/额定电压	60V
Rated current(40°C)/额定电流	4A
Standards/标准	IEC 61076-2-101
Termination/焊接方式	screw clamp/螺锁
Degree of protection/防护等级	IP67
Wire gauge(mm²)/线规(平方数)	0.14mm²-0.75mm²
Wire gauge(AWG)/线号(平方数)	26AWG-18AWG
Suitable cable outer diameter/适合线材外径	4.0mm-8.0mm
Mechanical operation/插拔次数	>100 mating cycles/大于100次
Ambient temperature (operation)/操作温度	-25°C~+85°C
Contact resistance/接触电阻	≤5mΩ
Insulation resistance/绝缘电阻	≥100MΩ
Connector body/胶芯	TPU
Pins/端子	Phosphorus copper with gold plated/磷铜镀金
Screw/螺丝	Brass with nickel plated/黄铜镀镍
Gasket/胶圈	Fluorine ring/氟胶圈
PG7: Cable diameter 4mm~6mm	PG9: Cable diameter 6mm~8mm
Environmental compliance/环境符合标准	RoHS, Reach

## M12 B code male right angle metal assembly connector with shielded/M12, B型公头弯头金属装配式连接器, 带屏蔽

### Illustration/尺寸

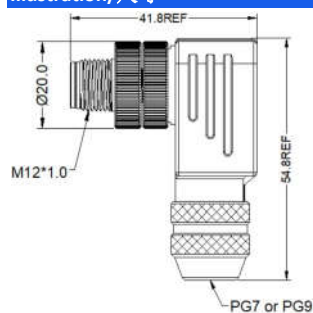

### Product photo/产品图



### Part number/产品料号

Pins/针数	Code/型	Part number/产品料号	
		PG7 thread/PG7螺纹	PG9 thread/PG9螺纹
5pins/5针	B code/B型	12ZS57-PG7	12ZS57-PG9

### Pin assignment front view/针位分布前视图

B code 5pins  
B型5针

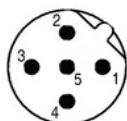

### General data/常规数据

Pins Numbers/针数	5pins/5针
Rated voltage/额定电压	60V
Rated current(40°C)/额定电流	4A
Standards/标准	IEC 61076-2-101
Termination/焊接方式	screw clamp/螺锁
Degree of protection/防护等级	IP67
Wire gauge(mm²)/线规(平方数)	0.14mm²-0.75mm²
Wire gauge(AWG)/线号(平方数)	26AWG-18AWG
Suitable cable outer diameter/适合线材外径	4.0mm-8.0mm
Mechanical operation/插拔次数	>100 mating cycles/大于100次
Ambient temperature (operation)/操作温度	-25°C~+85°C
Contact resistance/接触电阻	≤5mΩ
Insulation resistance/绝缘电阻	≥100MΩ
Connector body/胶芯	TPU
Pins/端子	Brass with gold plated/黄铜镀金
Screw/螺丝	Brass with nickel plated/黄铜镀镍
Gasket/胶圈	Fluorine ring/氟胶圈
PG7: Cable diameter 4mm~6mm	PG9: Cable diameter 6mm~8mm
Environmental compliance/环境符合标准	RoHs, Reach

## M12 B code female right angle metal assembly connector with shielded/M12, B型母头弯头金属装配式连接器, 带屏蔽

### Illustration/尺寸

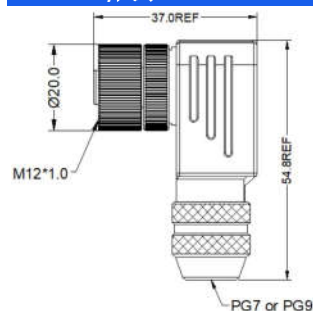

### Product photo/产品图



### Part number/产品料号

Pins/孔数	Code/型	Part number/产品料号	
		PG7 thread/PG7螺纹	PG9 thread/PG9螺纹
5pins/5孔	B code/B型	12ZS58-PG7	12ZS58-PG9

### Pin assignment front view/孔位分布前视图

B code 5pins  
B型5孔

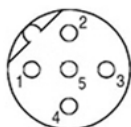

### General data/常规数据

Pins Numbers/孔数	5pins/5孔
Rated voltage/额定电压	60V
Rated current(40°C)/额定电流	4A
Standards/标准	IEC 61076-2-101
Termination/焊接方式	screw clamp/螺锁
Degree of protection/防护等级	IP67
Wire gauge(mm²)/线规(平方数)	0.14mm²-0.75mm²
Wire gauge(AWG)/线号(平方数)	26AWG-18AWG
Suitable cable outer diameter/适合线材外径	4.0mm-8.0mm
Mechanical operation/插拔次数	>100 mating cycles/大于100次
Ambient temperature (operation)/操作温度	-25°C~+85°C
Contact resistance/接触电阻	≤5mΩ
Insulation resistance/绝缘电阻	≥100MΩ
Connector body/胶芯	TPU
Pins/端子	Phosphorus copper with gold plated/磷铜镀金
Screw/螺丝	Brass with nickel plated/黄铜镀镍
Gasket/胶圈	Fluorine ring/氟胶圈
PG7: Cable diameter 4mm~6mm	PG9: Cable diameter 6mm~8mm
Environmental compliance/环境符合标准	RoHs, Reach



## M12 B code male straight molded cable, unshielded/M12, B型公头直头成型式连接线, 不带屏蔽

### Illustration/尺寸

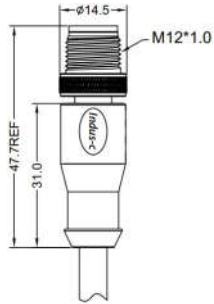

### Product photo/产品图



### Part number/产品料号

Pins/针数	Code/型	Part number("X" is length millimetre mm)/产品料号("X"表示长度, 单位毫米mm)		
		PVC jacket/PVC外被	PUR jacket/PUR外被	
5pins/5针	B code/B型	-10°C~+80°C	-40°C~+105°C	-40°C~+105°C
		12L00313-X	12L00314-X	12L00315-X

### Pin assignment front view/针位分布前视图

B code 5pins  
B型5针



### General data/常规数据

Pins Numbers/针数	5pins/5针
Rated voltage/额定电压	60V
Rated current(40°C)/额定电流	4A
Standards/标准	IEC 61076-2-101
Termination/焊接方式	solder and over-mold/焊接和成型
Degree of protection/防护等级	IP67, IP68, IP69K
Wire gauge(mm²)/线规(平方数)	0.14mm²-0.75mm²
Wire gauge(AWG)/线号(平方数)	26AWG-18AWG
Mechanical operation/插拔次数	>100 mating cycles/大于100次
Contact resistance/接触电阻	≤5mΩ
Insulation resistance/绝缘电阻	≥100MΩ
Connector body/胶芯	TPU
Pins/端子	Brass with gold plated/黄铜镀金
Screw/螺丝	Brass with nickel plated/黄铜镀镍
Environmental compliance/环境符合标准	RoHs, Reach

## M12 B code female straight molded cable, unshielded/M12, B型母头直头成型式连接线, 不带屏蔽

### Illustration/尺寸

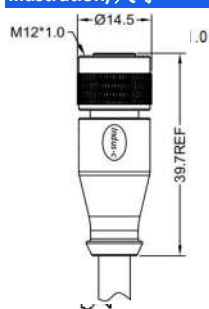

### Product photo/产品图



### Part number/产品料号

Pins/孔数	Code/型	Part number("X" is length millimetre mm)/产品料号("X"表示长度, 单位毫米mm)		
		PVC jacket/PVC外被	PUR jacket/PUR外被	
5pins/5孔	B code/B型	-10°C~+80°C	-40°C~+105°C	-40°C~+105°C
		12L00316-X	12L00317-X	12L00318-X

### Pin assignment front view/孔位分布前视图

B code 5pins  
B型5针

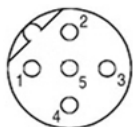

### General data/常规数据

Pins Numbers/孔数	5pins/5孔
Rated voltage/额定电压	60V
Rated current(40°C)/额定电流	4A
Standards/标准	IEC 61076-2-101
Termination/焊接方式	solder and over-mold/焊接和成型
Degree of protection/防护等级	IP67, IP68, IP69K
Wire gauge(mm²)/线规(平方数)	0.14mm²-0.75mm²
Wire gauge(AWG)/线号(平方数)	26AWG-18AWG
Mechanical operation/插拔次数	>100 mating cycles/大于100次
Contact resistance/接触电阻	≤5mΩ
Insulation resistance/绝缘电阻	≥100MΩ
Connector body/胶芯	TPU
Pins/端子	Phosphorus copper with gold plated/磷铜镀金
Screw/螺丝	Brass with nickel plated/黄铜镀镍
Environmental compliance/环境符合标准	RoHs, Reach

## M12 B code male straight molded cable, shielded/M12, B型公头直头成型式连接线, 带屏蔽

### Illustration/尺寸

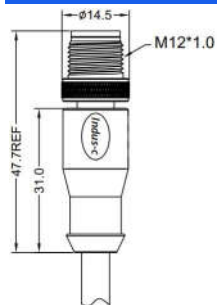

### Product photo/产品图



### Part number/产品料号

Pins/针数	Code/型	Part number("X" is length millimetre mm)/产品料号("X"表示长度, 单位毫米mm)		
		PVC jacket/PVC外被	PUR jacket/PUR外被	
5pins/5针	B code/B型	-10°C~+80°C	-40°C~+105°C	-40°C~+105°C
		12L00325-X	12L00326-X	12L00327-X

### Pin assignment front view/针位分布前视图

B code 5pins  
B型5针

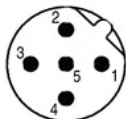

### General data/常规数据

Pins Numbers/针数	5pins/5针
Rated voltage/额定电压	60V
Rated current(40°C)/额定电流	4A
Standards/标准	IEC 61076-2-101
Termination/焊接方式	solder and over-mold/焊接和成型
Degree of protection/防护等级	IP67, IP68, IP69K
Wire gauge(mm²)/线规(平方数)	0.14mm²-0.75mm²
Wire gauge(AWG)/线号(平方数)	26AWG-18AWG
Mechanical operation/插拔次数	>100 mating cycles/大于100次
Contact resistance/接触电阻	≤5mΩ
Insulation resistance/绝缘电阻	≥100MΩ
Connector body/胶芯	TPU
Pins/端子	Brass with gold plated/黄铜镀金
Screw/螺丝	Brass with nickel plated/黄铜镀镍
Environmental compliance/环境符合标准	RoHs, Reach

## M12 B code female straight molded cable, shielded/M12, B型母头直头成型式连接线, 带屏蔽

### Illustration/尺寸

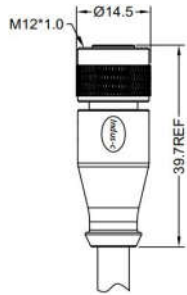

### Product photo/产品图



### Part number/产品料号

Pins/孔数	Code/型	Part number("X" is length millimetre mm)/产品料号("X"表示长度, 单位毫米mm)		
		PVC jacket/PVC外被	PUR jacket/PUR外被	
5pins/5孔	B code/B型	-10°C~+80°C	-40°C~+105°C	-40°C~+105°C
		12L00328-X	12L00329-X	12L00330-X

### Pin assignment front view/孔位分布前视图

B code 5pins  
B型5针

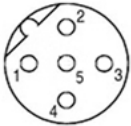

### General data/常规数据

Pins Numbers/孔数	5pins/5孔
Rated voltage/额定电压	60V
Rated current(40°C)/额定电流	4A
Standards/标准	IEC 61076-2-101
Termination/焊接方式	solder and over-mold/焊接和成型
Degree of protection/防护等级	IP67, IP68, IP69K
Wire gauge(mm²)/线规(平方数)	0.14mm²-0.75mm²
Wire gauge(AWG)/线号(平方数)	26AWG-18AWG
Mechanical operation/插拔次数	>100 mating cycles/大于100次
Contact resistance/接触电阻	≤5mΩ
Insulation resistance/绝缘电阻	≥100MΩ
Connector body/胶芯	TPU
Pins/端子	Phosphorus copper with gold plated/磷铜镀金
Screw/螺丝	Brass with nickel plated/黄铜镀镍
Environmental compliance/环境符合标准	RoHs, Reach

## M12 B code male right angle molded cable, unshielded/M12, B型公头弯头成型式连接线, 不带屏蔽

Illustration/尺寸

Product photo/产品图

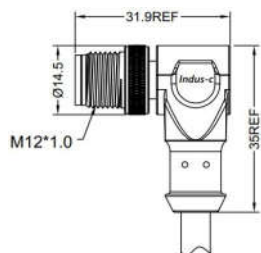

### Part number/产品料号

Pins/针数	Code/型	Part number("X" is length millimetre mm)/产品料号("X"表示长度, 单位毫米mm)		
		PVC jacket/PVC外被	PUR jacket/PUR外被	
5pins/5针	B code/B型	-10°C~+80°C	-40°C~+105°C	-40°C~+105°C
		12L00319-X	12L00320-X	12L00321-X

### Pin assignment front view/针位分布前视图

B code 5pins  
B型5针

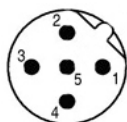

### General data/常规数据

Pins Numbers/针数	5pins/5针
Rated voltage/额定电压	60V
Rated current(40°C)/额定电流	4A
Standards/标准	IEC 61076-2-101
Termination/焊接方式	solder and over-mold/焊接和成型
Degree of protection/防护等级	IP67, IP68, IP69K
Wire gauge(mm²)/线规(平方数)	0.14mm²-0.75mm²
Wire gauge(AWG)/线号(平方数)	26AWG-18AWG
Mechanical operation/插拔次数	>100 mating cycles/大于100次
Contact resistance/接触电阻	≤5mΩ
Insulation resistance/绝缘电阻	≥100MΩ
Connector body/胶芯	TPU
Pins material/端子	Brass with gold plated/黄铜镀金
Screw/螺丝	Brass with nickel plated/黄铜镀镍
Environmental compliance/环境符合标准	RoHS, Reach

## M12 B code female right angle molded cable, unshielded/M12, B型母头弯头成型式连接线, 不带屏蔽

Illustration/尺寸

Product photo/产品图

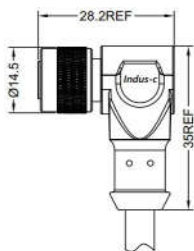

### Part number/产品料号

Pins/孔数	Code/型	Part number("X" is length millimetre mm)/产品料号("X"表示长度, 单位毫米mm)		
		PVC jacket/PVC外被	PUR jacket/PUR外被	
5pins/5孔	B code/B型	-10°C~+80°C	-40°C~+105°C	-40°C~+105°C
		12L00322-X	12L00323-X	12L00324-X

### Pin assignment front view/孔位分布前视图

B code 5pins  
B型5针

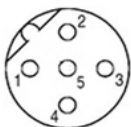

### General data/常规数据

Pins Numbers/孔数	5pins/5孔
Rated voltage/额定电压	60V
Rated current(40°C)/额定电流	4A
Standards/标准	IEC 61076-2-101
Termination/焊接方式	solder and over-mold/焊接和成型
Degree of protection/防护等级	IP67, IP68, IP69K
Wire gauge(mm²)/线规(平方数)	0.14mm²-0.75mm²
Wire gauge(AWG)/线号(平方数)	26AWG-18AWG
Mechanical operation/插拔次数	>100 mating cycles/大于100次
Contact resistance/接触电阻	≤5mΩ
Insulation resistance/绝缘电阻	≥100MΩ
Connector body/胶芯	TPU
Pins/端子	Phosphorus copper with gold plated/磷铜镀金
Screw/螺丝	Brass with nickel plated/黄铜镀镍
Environmental compliance/环境符合标准	RoHs, Reach

## M12 B code male right angle molded cable, shielded/M12, B型公头弯头成型式连接线, 带屏蔽

Illustration/尺寸

Product photo/产品图

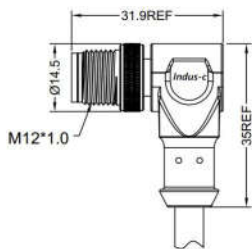

### Part number/产品料号

Pins/针数	Code/型	Part number("X" is length millimetre mm)/产品料号("X"表示长度, 单位毫米mm)		
		PVC jacket/PVC外被	PUR jacket/PUR外被	
		-10°C~+80°C	-40°C~+105°C	-40°C~+105°C
5pins/5针	B code/B型	12L00331-X	12L00332-X	12L00333-X

### Pin assignment front view/针位分布前视图

B code 5pins  
B型5针

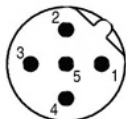

### General data/常规数据

Pins Numbers/针数	5pins/5针
Rated voltage/额定电压	60V
Rated current(40°C)/额定电流	4A
Standards/标准	IEC 61076-2-101
Termination/焊接方式	solder and over-mold/焊接和成型
Degree of protection/防护等级	IP67, IP68, IP69K
Wire gauge(mm²)/线规(平方数)	0.14mm²-0.75mm²
Wire gauge(AWG)/线号(平方数)	26AWG-18AWG
Mechanical operation/插拔次数	>100 mating cycles/大于100次
Contact resistance/接触电阻	≤5mΩ
Insulation resistance/绝缘电阻	≥100MΩ
Connector body/胶芯	TPU
Pins/端子	Brass with gold plated/黄铜镀金
Screw/螺丝	Brass with nickel plated/黄铜镀镍
Environmental compliance/环境符合标准	RoHS, Reach

## M12 B code female right angle molded cable, shielded/M12, B型母头弯头成型式连接线, 带屏蔽

Illustration/尺寸

Product photo/产品图

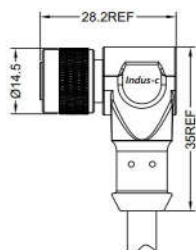

### Part number/产品料号

Pins/孔数	Code/型	Part number("X" is length millimetre mm)/产品料号("X"表示长度, 单位毫米mm)		
		PVC jacket/PVC外被	PUR jacket/PUR外被	
5pins/5孔	B code/B型	-10°C~+80°C	-40°C~+105°C	-40°C~+105°C
		12L00334-X	12L00335-X	12L00336-X

### Pin assignment front view/孔位分布前视图

B code 5pins  
B型5针

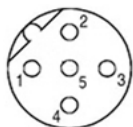

### General data/常规数据

Pins Numbers/孔数	5pins/5孔
Rated voltage/额定电压	60V
Rated current(40°C)/额定电流	4A
Standards/标准	IEC 61076-2-101
Termination/焊接方式	solder and over-mold/焊接和成型
Degree of protection/防护等级	IP67, IP68, IP69K
Wire gauge(mm²)/线规(平方数)	0.14mm²-0.75mm²
Wire gauge(AWG)/线号(平方数)	26AWG-18AWG
Mechanical operation/插拔次数	>100 mating cycles/大于100次
Contact resistance/接触电阻	≤5mΩ
Insulation resistance/绝缘电阻	≥100MΩ
Connector body/胶芯	TPU
Pins/端子	Phosphorus copper with gold plated/磷铜镀金
Screw/螺丝	Brass with nickel plated/黄铜镀镍
Environmental compliance/环境符合标准	RoHs, Reach



**M12 B code male to male right angle molded cable, unshielded/M12, B型公头弯头对公头弯头连接线, 不带屏蔽**

**Illustration/尺寸**

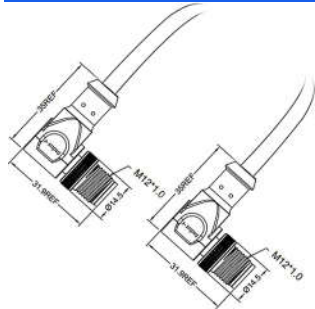

**Product photo/产品图**



**Part number/产品料号**

Pins/针数	Code/型	Part number("X" is length millimetre mm)/产品料号("X"表示长度, 单位毫米mm)		
		PVC jacket/PVC外被	PUR jacket/PUR外被	
5pins/5针	B code/B型	-10°C~+80°C	-40°C~+105°C	-40°C~+105°C
		12L00886-X	12L00887-X	12L00888-X

**Pin assignment front view/针位分布前视图**

B code 5pins  
B型5针



**General data/常规数据**

Pins Numbers/针数	5pins/5针
Rated voltage/额定电压	60V
Rated current(40°C)/额定电流	4A
Standards/标准	IEC 61076-2-101
Termination/焊接方式	solder and over-mold/焊接和成型
Degree of protection/防护等级	IP67, IP68, IP69K
Wire gauge(mm²)/线规(平方数)	0.14mm²-0.75mm²
Wire gauge(AWG)/线号(平方数)	26AWG-18AWG
Mechanical operation/插拔次数	>100 mating cycles/大于100次
Contact resistance/接触电阻	≤5mΩ
Insulation resistance/绝缘电阻	≥100MΩ
Connector body/胶芯	TPU
Pins/端子	Brass with gold plated/黄铜镀金
Screw/螺丝	Brass with nickel plated/黄铜镀镍
Environmental compliance/环境符合标准	RoHs, Reach

## M12 B code male to female right angle molded cable, unshielded/M12, B型公头弯头对母头弯头连接线, 不带屏蔽

Illustration/尺寸

Product photo/产品图

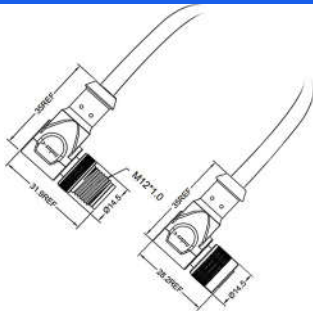

Part number/产品料号

Pins/针数	Code/型	Part number("X" is length millimetre mm)/产品料号("X"表示长度, 单位毫米mm)		
		PVC jacket/PVC外被	PUR jacket/PUR外被	
5pins/5针	B code/B型	-10°C~+80°C	-40°C~+105°C	-40°C~+105°C
		12L00889-X	12L00890-X	12L00891-X

Pin assignment front view/针位分布前视图

B code 5pins  
B型5针

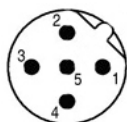

B型5针

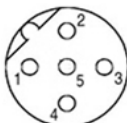

General data/常规数据

Pins Numbers/针数	5pins/5针
Rated voltage/额定电压	60V
Rated current(40°C)/额定电流	4A
Standards/标准	IEC 61076-2-101
Termination/焊接方式	solder and over-mold/焊接和成型
Degree of protection/防护等级	IP67, IP68, IP69K
Wire gauge(mm²)/线规(平方数)	0.14mm²-0.75mm²
Wire gauge(AWG)/线号(平方数)	26AWG-18AWG
Mechanical operation/插拔次数	>100 mating cycles/大于100次
Contact resistance/接触电阻	≤5mΩ
Insulation resistance/绝缘电阻	≥100MΩ
Connector body/胶芯	TPU
Male pin/公端子	Brass with gold plated/黄铜镀金
Screw/螺丝	Brass with nickel plated/黄铜镀镍
Shielded shell/屏蔽罩	Brass with nickel plated/黄铜镀镍
Over-mold/成型	TPU
Female pin/母端子	Phosphorus copper with gold plated/磷铜镀金
Environmental compliance/环境符合标准	ROHS, Reach

## M12 B code male right angle to female straight molded cable, unshielded/M12, B型公头弯头对母头直头成型式连接线, 不带屏蔽

### Illustration/尺寸

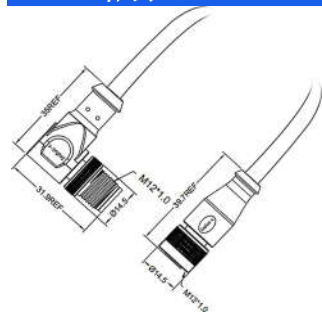

### Product photo/产品图



### Part number/产品料号

Pins/针数	Code/型	Part number("X" is length millimetre mm)/产品料号("X"表示长度, 单位毫米mm)		
		PVC jacket/PVC外被	PUR jacket/PUR外被	
5pins/5针	B code/B型	-10°C~+80°C	-40°C~+105°C	-40°C~+105°C
		12L00892-X	12L00893-X	12L00894-X

### Pin assignment front view/针位分布前视图

B code 5pins  
B型5针



B型5针

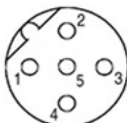

### General data/常规数据

Pins Numbers/针数	5pins/5针
Rated voltage/额定电压	60V
Rated current(40°C)/额定电流	4A
Standards/标准	IEC 61076-2-101
Termination/焊接方式	solder and over-mold/焊接和成型
Degree of protection/防护等级	IP67, IP68, IP69K
Wire gauge(mm²)/线规(平方数)	0.14mm²-0.75mm²
Wire gauge(AWG)/线号(平方数)	26AWG-18AWG
Mechanical operation/插拔次数	>100 mating cycles/大于100次
Contact resistance/接触电阻	≤5mΩ
Insulation resistance/绝缘电阻	≥100MΩ
Connector body/胶芯	TPU
Male pin/公端子	Brass with gold plated/黄铜镀金
Screw/螺丝	Brass with nickel plated/黄铜镀镍
Shielded shell/屏蔽罩	Brass with nickel plated/黄铜镀镍
Over-mold/成型	TPU
Female pin/母端子	Phosphorus copper with gold plated/磷铜镀金
Environmental compliance/环境符合标准	ROHS, Reach

## M12 B code male straight to male right angle molded cable, unshielded/M12, B型公头直头对公头弯头连接线, 不带屏蔽

### Illustration/尺寸

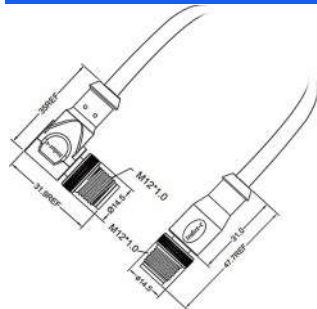

### Product photo/产品图



### Part number/产品料号

Pins/针数	Code/型	Part number("X" is length millimetre mm)/产品料号("X"表示长度, 单位毫米mm)		
		PVC jacket/PVC外被	PUR jacket/PUR外被	
5pins/5针	B code/B型	-10°C~+80°C	-40°C~+105°C	-40°C~+105°C
		12L00895-X	12L00896-X	12L00897-X

### Pin assignment front view/针位分布前视图

B code 5pins  
B型5针

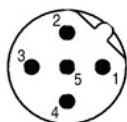

### General data/常规数据

Pins Numbers/针数	5pins/5针
Rated voltage/额定电压	60V
Rated current(40°C)/额定电流	4A
Standards/标准	IEC 61076-2-101
Termination/焊接方式	solder and over-mold/焊接和成型
Degree of protection/防护等级	IP67, IP68, IP69K
Wire gauge(mm²)/线规(平方数)	0.14mm²-0.75mm²
Wire gauge(AWG)/线号(平方数)	26AWG-18AWG
Mechanical operation/插拔次数	>100 mating cycles/大于100次
Contact resistance/接触电阻	≤5mΩ
Insulation resistance/绝缘电阻	≥100MΩ
Connector body/胶芯	TPU
Pins/端子	Brass with gold plated/黄铜镀金
Screw/螺丝	Brass with nickel plated/黄铜镀镍
Environmental compliance/环境符合标准	RoHs, Reach

## M12 B code male to male straight molded cable, unshielded/M12, B型公头直头对公头直头连接线, 不带屏蔽

Illustration/尺寸

Product photo/产品图

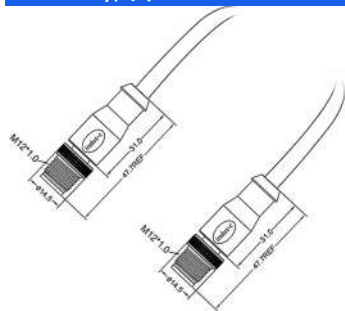

Part number/产品料号

Pins/针数	Code/型	Part number("X" is length millimetre mm)/产品料号("X"表示长度, 单位毫米mm)		
		PVC jacket/PVC外被	PUR jacket/PUR外被	
5pins/5针	B code/B型	-10°C~+80°C	-40°C~+105°C	-40°C~+105°C
		12L00898-X	12L00899-X	12L00900-X

Pin assignment front view/针位分布前视图

B code 5pins  
B型5针

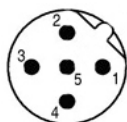

General data/常规数据

Pins Numbers/针数	5pins/5针
Rated voltage/额定电压	60V
Rated current(40°C)/额定电流	4A
Standards/标准	IEC 61076-2-101
Termination/焊接方式	solder and over-mold/焊接和成型
Degree of protection/防护等级	IP67, IP68, IP69K
Wire gauge(mm²)/线规(平方数)	0.14mm²-0.75mm²
Wire gauge(AWG)/线号(平方数)	26AWG-18AWG
Mechanical operation/插拔次数	>100 mating cycles/大于100次
Contact resistance/接触电阻	≤5mΩ
Insulation resistance/绝缘电阻	≥100MΩ
Connector body/胶芯	TPU
Pins/端子	Brass with gold plated/黄铜镀金
Screw/螺丝	Brass with nickel plated/黄铜镀镍
Environmental compliance/环境符合标准	RoHs, Reach

## M12 B code male straight to female right angle molded cable, unshielded/M12, B型公头直头对母头弯头连接线, 不带屏蔽

### Illustration/尺寸

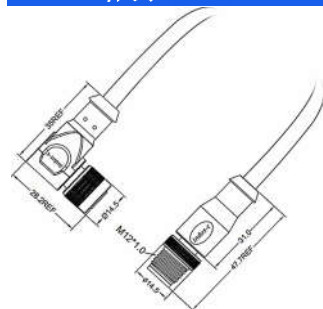

### Product photo/产品图



### Part number/产品料号

Pins/针数	Code/型	Part number("X" is length millimetre mm)/产品料号("X"表示长度, 单位毫米mm)		
		PVC jacket/PVC外被	PUR jacket/PUR外被	
5pins/5针	B code/B型	-10°C~+80°C	-40°C~+105°C	-40°C~+105°C
		12L00901-X	12L00902-X	12L00903-X

### Pin assignment front view/针位分布前视图

B code 5pins  
B型5针

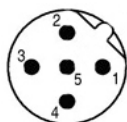

B型5针

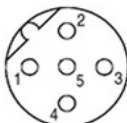

### General data/常规数据

Pins Numbers/针数	5pins/5针
Rated voltage/额定电压	60V
Rated current(40°C)/额定电流	4A
Standards/标准	IEC 61076-2-101
Termination/焊接方式	solder and over-mold/焊接和成型
Degree of protection/防护等级	IP67, IP68, IP69K
Wire gauge(mm²)/线规(平方数)	0.14mm²-0.75mm²
Wire gauge(AWG)/线号(平方数)	26AWG-18AWG
Mechanical operation/插拔次数	>100 mating cycles/大于100次
Contact resistance/接触电阻	≤5mΩ
Insulation resistance/绝缘电阻	≥100MΩ
Connector body/胶芯	TPU
Male pin/公端子	Brass with gold plated/黄铜镀金
Screw/螺丝	Brass with nickel plated/黄铜镀镍
Shielded shell/屏蔽罩	Brass with nickel plated/黄铜镀镍
Over-mold/成型	TPU
Female pin/母端子	Phosphorus copper with gold plated/磷铜镀金
Environmental compliance/环境符合标准	ROHS, Reach

## M12 B code male to female straight molded cable, unshielded/M12, B型公头直头对母头直头连接线, 不带屏蔽

Illustration/尺寸

Product photo/产品图

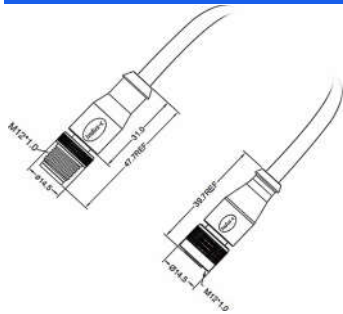

Part number/产品料号

Pins/针数	Code/型	Part number("X" is length millimetre mm)/产品料号("X"表示长度, 单位毫米mm)		
		PVC jacket/PVC外被	PUR jacket/PUR外被	
5pins/5针	B code/B型	-10°C~+80°C	-40°C~+105°C	-40°C~+105°C
		12L00904-X	12L00905-X	12L00906-X

Pin assignment front view/针位分布前视图

B code 5pins  
B型5针

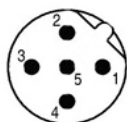

B型5针

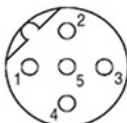

General data/常规数据

Pins Numbers/针数	5pins/5针
Rated voltage/额定电压	60V
Rated current(40°C)/额定电流	4A
Standards/标准	IEC 61076-2-101
Termination/焊接方式	solder and over-mold/焊接和成型
Degree of protection/防护等级	IP67, IP68, IP69K
Wire gauge(mm²)/线规(平方数)	0.14mm²-0.75mm²
Wire gauge(AWG)/线号(平方数)	26AWG-18AWG
Mechanical operation/插拔次数	>100 mating cycles/大于100次
Contact resistance/接触电阻	≤5mΩ
Insulation resistance/绝缘电阻	≥100MΩ
Connector body/胶芯	TPU
Male pin/公端子	Brass with gold plated/黄铜镀金
Screw/螺丝	Brass with nickel plated/黄铜镀镍
Shielded shell/屏蔽罩	Brass with nickel plated/黄铜镀镍
Over-mold/成型	TPU
Female pin/母端子	Phosphorus copper with gold plated/磷铜镀金
Environmental compliance/环境符合标准	ROHS, Reach

## M12 Bcode female to female right angle molded cable, unshielded/M12, B型母头弯头对母头弯头连接线, 不带屏蔽

Illustration/尺寸

Product photo/产品图

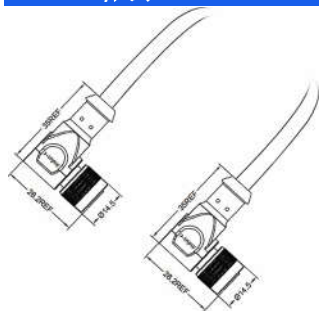

Part number/产品料号

Pins/孔数	Code/型	Part number("X" is length millimetre mm)/产品料号("X"表示长度, 单位毫米mm)		
		PVC jacket/PVC外被	PUR jacket/PUR外被	
5pins/5孔	B code/B型	-10°C~+80°C	-40°C~+105°C	-40°C~+105°C
		12L00907-X	12L00908-X	12L00909-X

Pin assignment front view/孔位分布前视图

B code 5pins  
B型5针

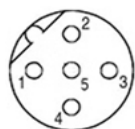

General data/常规数据

Pins Numbers/孔数	5pins/5孔
Rated voltage/额定电压	60V
Rated current(40°C)/额定电流	4A
Standards/标准	IEC 61076-2-101
Termination/焊接方式	solder and over-mold/焊接和成型
Degree of protection/防护等级	IP67, IP68, IP69K
Wire gauge(mm²)/线规(平方数)	0.14mm²-0.75mm²
Wire gauge(AWG)/线号(平方数)	26AWG-18AWG
Mechanical operation/插拔次数	>100 mating cycles/大于100次
Contact resistance/接触电阻	≤5mΩ
Insulation resistance/绝缘电阻	≥100MΩ
Connector body/胶芯	TPU
Pins/端子	Phosphorus copper with gold plated/磷铜镀金
Screw/螺丝	Brass with nickel plated/黄铜镀镍
Environmental compliance/环境符合标准	RoHs, Reach



## M12 B code female straight to female right angle molded cable, unshielded/M12, B型母头直头对母头弯头连接线, 不带屏蔽

### Illustration/尺寸

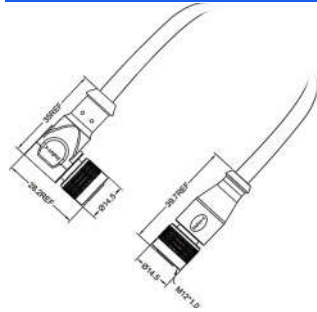

### Product photo/产品图



### Part number/产品料号

Pins/孔数	Code/型	Part number("X" is length millimetre mm)/产品料号("X"表示长度, 单位毫米mm)		
		PVC jacket/PVC外被	PUR jacket/PUR外被	
5pins/5孔	B code/B型	-10°C~+80°C	-40°C~+105°C	-40°C~+105°C
		12L00910-X	12L00911-X	12L00912-X

### Pin assignment front view/孔位分布前视图

B code 5pins  
B型5针



### General data/常规数据

Pins Numbers/孔数	5pins/5孔
Rated voltage/额定电压	60V
Rated current(40°C)/额定电流	4A
Standards/标准	IEC 61076-2-101
Termination/焊接方式	solder and over-mold/焊接和成型
Degree of protection/防护等级	IP67, IP68, IP69K
Wire gauge(mm²)/线规(平方数)	0.14mm²-0.75mm²
Wire gauge(AWG)/线号(平方数)	26AWG-18AWG
Mechanical operation/插拔次数	>100 mating cycles/大于100次
Contact resistance/接触电阻	≤5mΩ
Insulation resistance/绝缘电阻	≥100MΩ
Connector body/胶芯	TPU
Pins/端子	Phosphorus copper with gold plated/磷铜镀金
Screw/螺丝	Brass with nickel plated/黄铜镀镍
Environmental compliance/环境符合标准	RoHs, Reach

## M12 B code female to female straight molded cable, unshielded/M12, B型母头直头对母头直头连接线, 不带屏蔽

Illustration/尺寸

Product photo/产品图

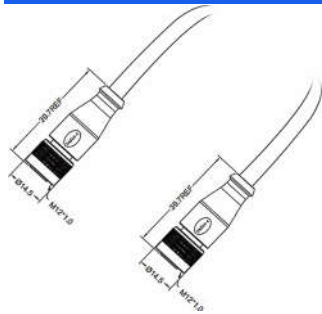

Part number/产品料号

Pins/孔数	Code/型	Part number("X" is length millimetre mm)/产品料号("X"表示长度, 单位毫米mm)		
		PVC jacket/PVC外被	PUR jacket/PUR外被	
5pins/5孔	B code/B型	-10°C~+80°C	-40°C~+105°C	-40°C~+105°C
		12L00913-X	12L00914-X	12L00915-X

Pin assignment front view/孔位分布前视图

B code 5pins  
B型5针

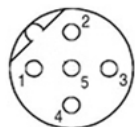

General data/常规数据

Pins Numbers/孔数	5pins/5孔
Rated voltage/额定电压	60V
Rated current(40°C)/额定电流	4A
Standards/标准	IEC 61076-2-101
Termination/焊接方式	solder and over-mold/焊接和成型
Degree of protection/防护等级	IP67, IP68, IP69K
Wire gauge(mm²)/线规(平方数)	0.14mm²-0.75mm²
Wire gauge(AWG)/线号(平方数)	26AWG-18AWG
Mechanical operation/插拔次数	>100 mating cycles/大于100次
Contact resistance/接触电阻	≤5mΩ
Insulation resistance/绝缘电阻	≥100MΩ
Connector body/胶芯	TPU
Pins/端子	Phosphorus copper with gold plated/磷铜镀金
Screw/螺丝	Brass with nickel plated/黄铜镀镍
Environmental compliance/环境符合标准	RoHs, Reach

## M12 B code male to male right angle molded cable, shielded/M12, B型公头弯头对公头弯头连接线, 带屏蔽

Illustration/尺寸

Product photo/产品图

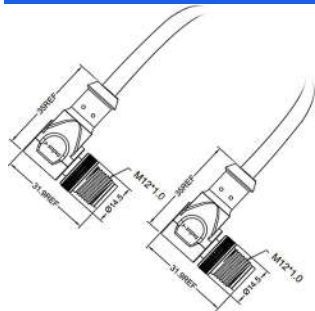

Part number/产品料号

Pins/针数	Code/型	Part number("X" is length millimetre mm)/产品料号("X"表示长度, 单位毫米mm)		
		PVC jacket/PVC外被	PUR jacket/PUR外被	
5pins/5针	B code/B型	-10°C~+80°C	-40°C~+105°C	-40°C~+105°C
		12L00916-X	12L00917-X	12L00502-X

Pin assignment front view/针位分布前视图

B code 5pins  
B型5针

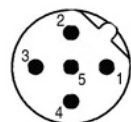

General data/常规数据

Pins Numbers/针数	5pins/5针
Rated voltage/额定电压	60V
Rated current(40°C)/额定电流	4A
Standards/标准	IEC 61076-2-101
Termination/焊接方式	solder and over-mold/焊接和成型
Degree of protection/防护等级	IP67, IP68, IP69K
Wire gauge(mm²)/线规(平方数)	0.14mm²-0.75mm²
Wire gauge(AWG)/线号(平方数)	26AWG-18AWG
Mechanical operation/插拔次数	>100 mating cycles/大于100次
Contact resistance/接触电阻	≤5mΩ
Insulation resistance/绝缘电阻	≥100MΩ
Connector body/胶芯	TPU
Pins/端子	Brass with gold plated/黄铜镀金
Screw/螺丝	Brass with nickel plated/黄铜镀镍
Environmental compliance/环境符合标准	RoHs, Reach

## M12 B code male to female right angle molded cable, shielded/M12, B型公头弯头对母头弯头连接线, 带屏蔽

Illustration/尺寸

Product photo/产品图

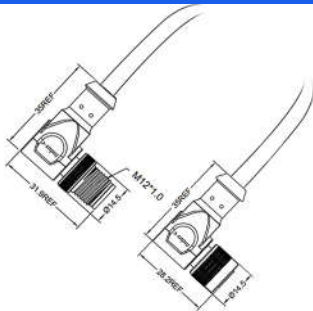

Part number/产品料号

Pins/针数	Code/型	Part number("X" is length millimetre mm)/产品料号("X"表示长度, 单位毫米mm)		
		PVC jacket/PVC外被	PUR jacket/PUR外被	
5pins/5针	B code/B型	-10°C~+80°C	-40°C~+105°C	-40°C~+105°C
		12L00918-X	12L00919-X	12L00920-X

Pin assignment front view/针位分布前视图

B code 5pins  
B型5针

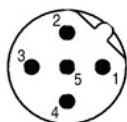

B型5针

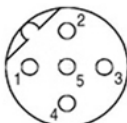

General data/常规数据

Pins Numbers/针数	5pins/5针
Rated voltage/额定电压	60V
Rated current(40°C)/额定电流	4A
Standards/标准	IEC 61076-2-101
Termination/焊接方式	solder and over-mold/焊接和成型
Degree of protection/防护等级	IP67, IP68, IP69K
Wire gauge(mm²)/线规(平方数)	0.14mm²-0.75mm²
Wire gauge(AWG)/线号(平方数)	26AWG-18AWG
Mechanical operation/插拔次数	>100 mating cycles/大于100次
Contact resistance/接触电阻	≤5mΩ
Insulation resistance/绝缘电阻	≥100MΩ
Connector body/胶芯	TPU
Male pin/公端子	Brass with gold plated/黄铜镀金
Screw/螺丝	Brass with nickel plated/黄铜镀镍
Shielded shell/屏蔽罩	Brass with nickel plated/黄铜镀镍
Over-mold/成型	TPU
Female pin/母端子	Phosphorus copper with gold plated/磷铜镀金
Environmental compliance/环境符合标准	ROHS, Reach

## M12 B code male right angle to female straight molded cable, shielded/M12, B型公头弯头对母头直头成型式连接线, 带屏蔽

Illustration/尺寸

Product photo/产品图

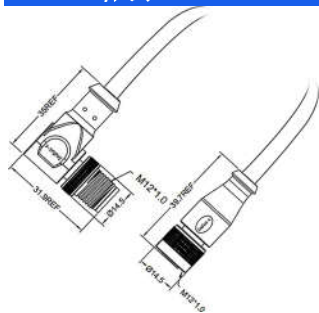

Part number/产品料号

Pins/针数	Code/型	Part number("X" is length millimetre mm)/产品料号("X"表示长度, 单位毫米mm)		
		PVC jacket/PVC外被	PUR jacket/PUR外被	
5pins/5针	B code/B型	-10°C~+80°C	-40°C~+105°C	-40°C~+105°C
		12L00921-X	12L00922-X	12L00923-X

Pin assignment front view/针位分布前视图

B code 5pins  
B型5针

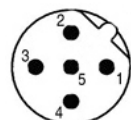

B型5针

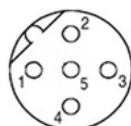

General data/常规数据

Pins Numbers/针数	5pins/5针
Rated voltage/额定电压	60V
Rated current(40°C)/额定电流	4A
Standards/标准	IEC 61076-2-101
Termination/焊接方式	solder and over-mold/焊接和成型
Degree of protection/防护等级	IP67, IP68, IP69K
Wire gauge(mm²)/线规(平方数)	0.14mm²-0.75mm²
Wire gauge(AWG)/线号(平方数)	26AWG-18AWG
Mechanical operation/插拔次数	>100 mating cycles/大于100次
Contact resistance/接触电阻	≤5mΩ
Insulation resistance/绝缘电阻	≥100MΩ
Connector body/胶芯	TPU
Male pin/公端子	Brass with gold plated/黄铜镀金
Screw/螺丝	Brass with nickel plated/黄铜镀镍
Shielded shell/屏蔽罩	Brass with nickel plated/黄铜镀镍
Over-mold/成型	TPU
Female pin/母端子	Phosphorus copper with gold plated/磷铜镀金
Environmental compliance/环境符合标准	ROHS, Reach

**M12 B code male straight to male right angle molded cable, shielded/M12, B型公头直头对公头弯头连接线, 带屏蔽**

**Illustration/尺寸**

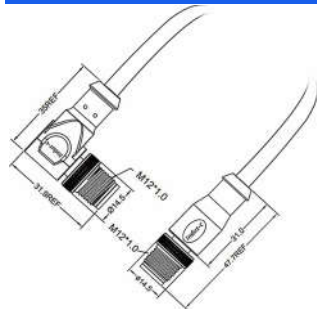

**Product photo/产品图**



**Part number/产品料号**

Pins/针数	Code/型	Part number("X" is length millimetre mm)/产品料号("X"表示长度, 单位毫米mm)		
		PVC jacket/PVC外被	PUR jacket/PUR外被	
5pins/5针	B code/B型	-10°C~+80°C	-40°C~+105°C	-40°C~+105°C
		12L00924-X	12L00925-X	12L00926-X

**Pin assignment front view/针位分布前视图**

B code 5pins  
 B型5针

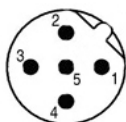

**General data/常规数据**

Pins Numbers/针数	5pins/5针
Rated voltage/额定电压	60V
Rated current(40°C)/额定电流	4A
Standards/标准	IEC 61076-2-101
Termination/焊接方式	solder and over-mold/焊接和成型
Degree of protection/防护等级	IP67, IP68, IP69K
Wire gauge(mm²)/线规(平方数)	0.14mm²-0.75mm²
Wire gauge(AWG)/线号(平方数)	26AWG-18AWG
Mechanical operation/插拔次数	>100 mating cycles/大于100次
Contact resistance/接触电阻	≤5mΩ
Insulation resistance/绝缘电阻	≥100MΩ
Connector body/胶芯	TPU
Pins/端子	Brass with gold plated/黄铜镀金
Screw/螺丝	Brass with nickel plated/黄铜镀镍
Environmental compliance/环境符合标准	RoHs, Reach

## M12 B code male to male straight molded cable, shielded/M12, B型公头直头对公头直头连接线, 带屏蔽

Illustration/尺寸

Product photo/产品图

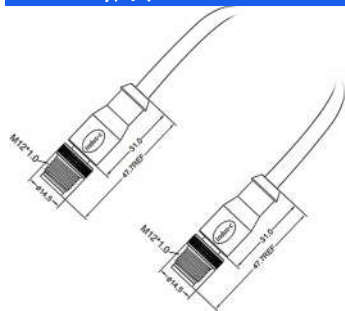

Part number/产品料号

Pins/针数	Code/型	Part number("X" is length millimetre mm)/产品料号("X"表示长度, 单位毫米mm)		
		PVC jacket/PVC外被	PUR jacket/PUR外被	
5pins/5针	B code/B型	-10°C~+80°C	-40°C~+105°C	-40°C~+105°C
		12L00927-X	12L00928-X	12L00929-X

Pin assignment front view/针位分布前视图

B code 5pins  
B型5针

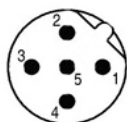

General data/常规数据

Pins Numbers/针数	5pins/5针
Rated voltage/额定电压	60V
Rated current(40°C)/额定电流	4A
Standards/标准	IEC 61076-2-101
Termination/焊接方式	solder and over-mold/焊接和成型
Degree of protection/防护等级	IP67, IP68, IP69K
Wire gauge(mm²)/线规(平方数)	0.14mm²-0.75mm²
Wire gauge(AWG)/线号(平方数)	26AWG-18AWG
Mechanical operation/插拔次数	>100 mating cycles/大于100次
Contact resistance/接触电阻	≤5mΩ
Insulation resistance/绝缘电阻	≥100MΩ
Connector body/胶芯	TPU
Pins/端子	Brass with gold plated/黄铜镀金
Screw/螺丝	Brass with nickel plated/黄铜镀镍
Environmental compliance/环境符合标准	RoHs, Reach

## M12 B code male straight to female right angle molded cable, shielded/M12, B型公头直头对母头弯头连接线, 带屏蔽

Illustration/尺寸

Product photo/产品图

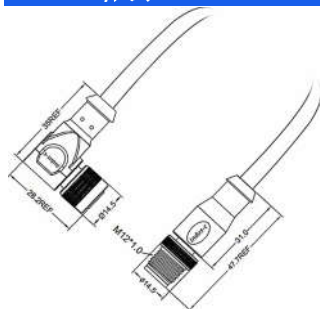

Part number/产品料号

Pins/针数	Code/型	Part number("X" is length millimetre mm)/产品料号("X"表示长度, 单位毫米mm)		
		PVC jacket/PVC外被	PUR jacket/PUR外被	
5pins/5针	B code/B型	-10°C~+80°C	-40°C~+105°C	-40°C~+105°C
		12L00930-X	12L00931-X	12L00932-X

Pin assignment front view/针位分布前视图

B code 5pins  
B型5针

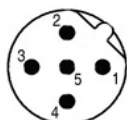

B型5针

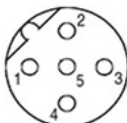

General data/常规数据

Pins Numbers/针数	5pins/5针
Rated voltage/额定电压	60V
Rated current(40°C)/额定电流	4A
Standards/标准	IEC 61076-2-101
Termination/焊接方式	solder and over-mold/焊接和成型
Degree of protection/防护等级	IP67, IP68, IP69K
Wire gauge(mm²)/线规(平方数)	0.14mm²-0.75mm²
Wire gauge(AWG)/线号(平方数)	26AWG-18AWG
Mechanical operation/插拔次数	>100 mating cycles/大于100次
Contact resistance/接触电阻	≤5mΩ
Insulation resistance/绝缘电阻	≥100MΩ
Connector body/胶芯	TPU
Male pin/公端子	Brass with gold plated/黄铜镀金
Screw/螺丝	Brass with nickel plated/黄铜镀镍
Shielded shell/屏蔽罩	Brass with nickel plated/黄铜镀镍
Over-mold/成型	TPU
Female pin/母端子	Phosphorus copper with gold plated/磷铜镀金
Environmental compliance/环境符合标准	ROHS, Reach



## M12 B code male to female straight molded cable, shielded/M12, B型公头直头对母头直头连接线, 带屏蔽

Illustration/尺寸

Product photo/产品图

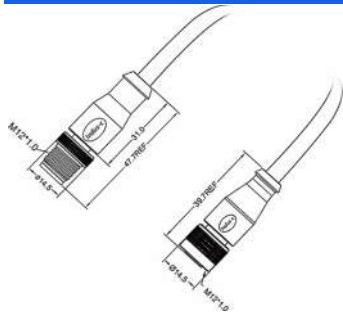

Part number/产品料号

Pins/针数	Code/型	Part number("X" is length millimetre mm)/产品料号("X"表示长度, 单位毫米mm)		
		PVC jacket/PVC外被	PUR jacket/PUR外被	
5pins/5针	B code/B型	-10°C~+80°C	-40°C~+105°C	-40°C~+105°C
		12L00933-X	12L00934-X	12L00935-X

Pin assignment front view/针位分布前视图

B code 5pins  
B型5针

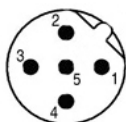

B型5针

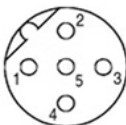

General data/常规数据

Pins Numbers/针数	5pins/5针
Rated voltage/额定电压	60V
Rated current(40°C)/额定电流	4A
Standards/标准	IEC 61076-2-101
Termination/焊接方式	solder and over-mold/焊接和成型
Degree of protection/防护等级	IP67, IP68, IP69K
Wire gauge(mm²)/线规(平方数)	0.14mm²-0.75mm²
Wire gauge(AWG)/线号(平方数)	26AWG-18AWG
Mechanical operation/插拔次数	>100 mating cycles/大于100次
Contact resistance/接触电阻	≤5mΩ
Insulation resistance/绝缘电阻	≥100MΩ
Connector body/胶芯	TPU
Male pin/公端子	Brass with gold plated/黄铜镀金
Screw/螺丝	Brass with nickel plated/黄铜镀镍
Shielded shell/屏蔽罩	Brass with nickel plated/黄铜镀镍
Over-mold/成型	TPU
Female pin/母端子	Phosphorus copper with gold plated/磷铜镀金
Environmental compliance/环境符合标准	ROHS, Reach

## M12 Bcode female to female right angle molded cable, shielded/M12, B型母头弯头对母头弯头连接线, 带屏蔽

Illustration/尺寸

Product photo/产品图

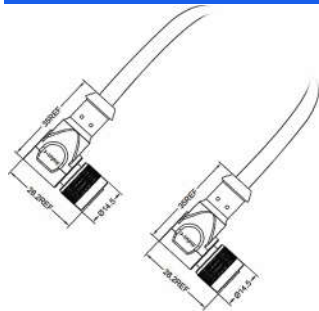

Part number/产品料号

Pins/孔数	Code/型	Part number("X" is length millimetre mm)/产品料号("X"表示长度, 单位毫米mm)		
		PVC jacket/PVC外被	PUR jacket/PUR外被	
5pins/5孔	B code/B型	-10°C~+80°C	-40°C~+105°C	-40°C~+105°C
		12L00936-X	12L00937-X	12L00938-X

Pin assignment front view/孔位分布前视图

B code 5pins  
B型5针

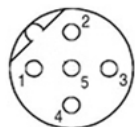

General data/常规数据

Pins Numbers/孔数	5pins/5孔
Rated voltage/额定电压	60V
Rated current(40°C)/额定电流	4A
Standards/标准	IEC 61076-2-101
Termination/焊接方式	solder and over-mold/焊接和成型
Degree of protection/防护等级	IP67, IP68, IP69K
Wire gauge(mm²)/线规(平方数)	0.14mm²-0.75mm²
Wire gauge(AWG)/线号(平方数)	26AWG-18AWG
Mechanical operation/插拔次数	>100 mating cycles/大于100次
Contact resistance/接触电阻	≤5mΩ
Insulation resistance/绝缘电阻	≥100MΩ
Connector body/胶芯	TPU
Pins/端子	Phosphorus copper with gold plated/磷铜镀金
Screw/螺丝	Brass with nickel plated/黄铜镀镍
Environmental compliance/环境符合标准	RoHs, Reach

## M12 B code female straight to female right angle molded cable, shielded/M12, B型母头直头对母头弯头连接线, 带屏蔽

### Illustration/尺寸 Product photo/产品图

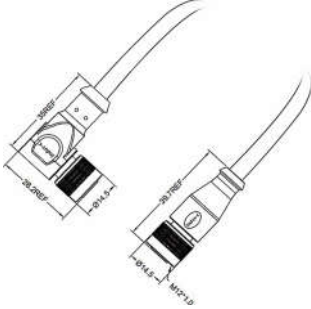

### Part number/产品料号

Pins/孔数	Code/型	Part number("X" is length millimetre mm)/产品料号("X"表示长度, 单位毫米mm)		
		PVC jacket/PVC外被	PUR jacket/PUR外被	
5pins/5孔	B code/B型	-10°C~+80°C	-40°C~+105°C	-40°C~+105°C
		12L00939-X	12L00940-X	12L00941-X

### Pin assignment front view/孔位分布前视图

B code 5pins  
 B型5针



### General data/常规数据

Pins Numbers/孔数	5pins/5孔
Rated voltage/额定电压	60V
Rated current(40°C)/额定电流	4A
Standards/标准	IEC 61076-2-101
Termination/焊接方式	solder and over-mold/焊接和成型
Degree of protection/防护等级	IP67, IP68, IP69K
Wire gauge(mm²)/线规(平方数)	0.14mm²-0.75mm²
Wire gauge(AWG)/线号(平方数)	26AWG-18AWG
Mechanical operation/插拔次数	>100 mating cycles/大于100次
Contact resistance/接触电阻	≤5mΩ
Insulation resistance/绝缘电阻	≥100MΩ
Connector body/胶芯	TPU
Pins/端子	Phosphorus copper with gold plated/磷铜镀金
Screw/螺丝	Brass with nickel plated/黄铜镀镍
Environmental compliance/环境符合标准	RoHs, Reach

## M12 B code female to female straight molded cable, shielded/M12, B型母头直头对母头直头连接线, 带屏蔽

Illustration/尺寸

Product photo/产品图

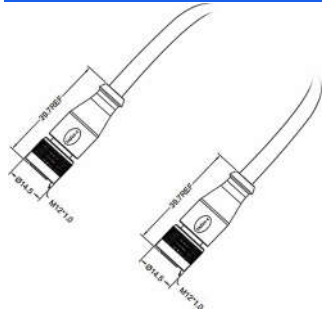

Part number/产品料号

Pins/孔数	Code/型	Part number("X" is length millimetre mm)/产品料号("X"表示长度, 单位毫米mm)		
		PVC jacket/PVC外被	PUR jacket/PUR外被	
5pins/5孔	B code/B型	-10°C~+80°C	-40°C~+105°C	-40°C~+105°C
		12L00942-X	12L00943-X	12L00944-X

Pin assignment front view/孔位分布前视图

B code 5pins  
B型5针

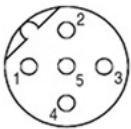

General data/常规数据

Pins Numbers/孔数	5pins/5孔
Rated voltage/额定电压	60V
Rated current(40°C)/额定电流	4A
Standards/标准	IEC 61076-2-101
Termination/焊接方式	solder and over-mold/焊接和成型
Degree of protection/防护等级	IP67, IP68, IP69K
Wire gauge(mm²)/线规(平方数)	0.14mm²-0.75mm²
Wire gauge(AWG)/线号(平方数)	26AWG-18AWG
Mechanical operation/插拔次数	>100 mating cycles/大于100次
Contact resistance/接触电阻	≤5mΩ
Insulation resistance/绝缘电阻	≥100MΩ
Connector body/胶芯	TPU
Pins/端子	Phosphorus copper with gold plated/磷铜镀金
Screw/螺丝	Brass with nickel plated/黄铜镀镍
Environmental compliance/环境符合标准	RoHs, Reach